

لینک درس جلسه دوم کارگاه برق

<https://vc6.semnan.ac.ir/psur6ni8kfsn/>

جلسه دوم

راه اندازی موتور تکفاز A

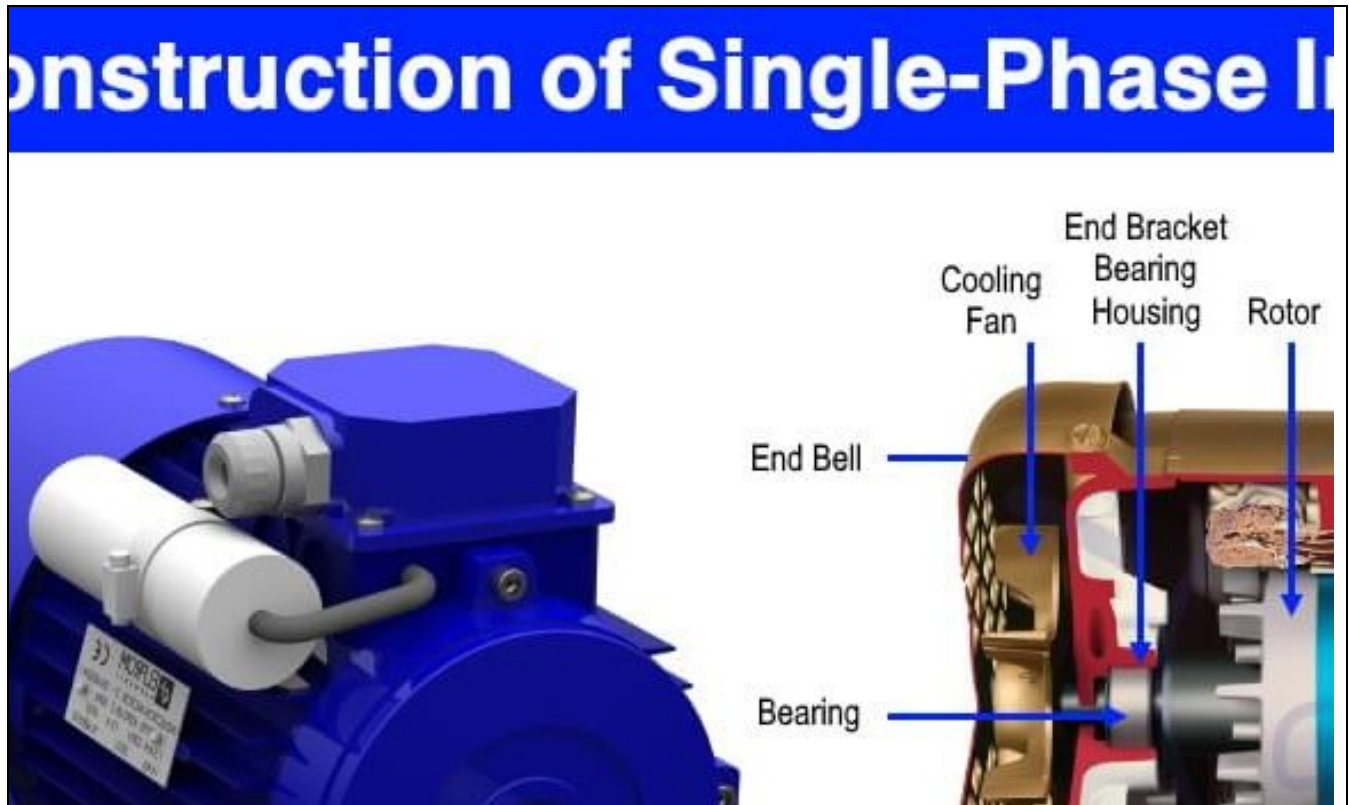

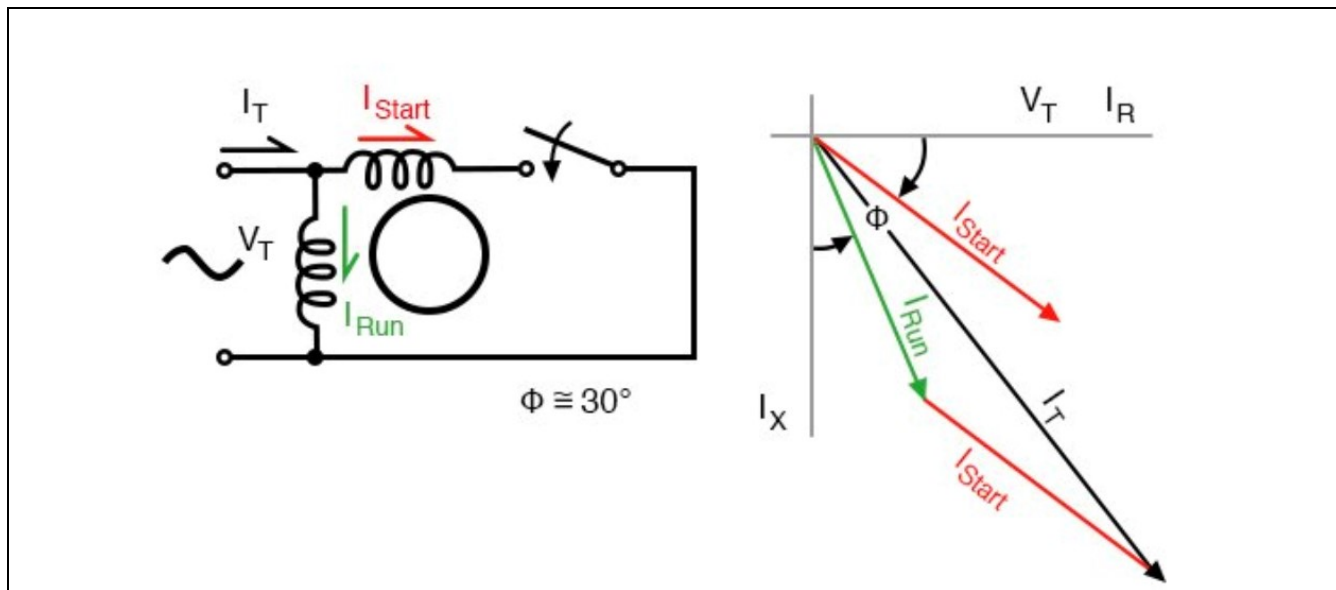

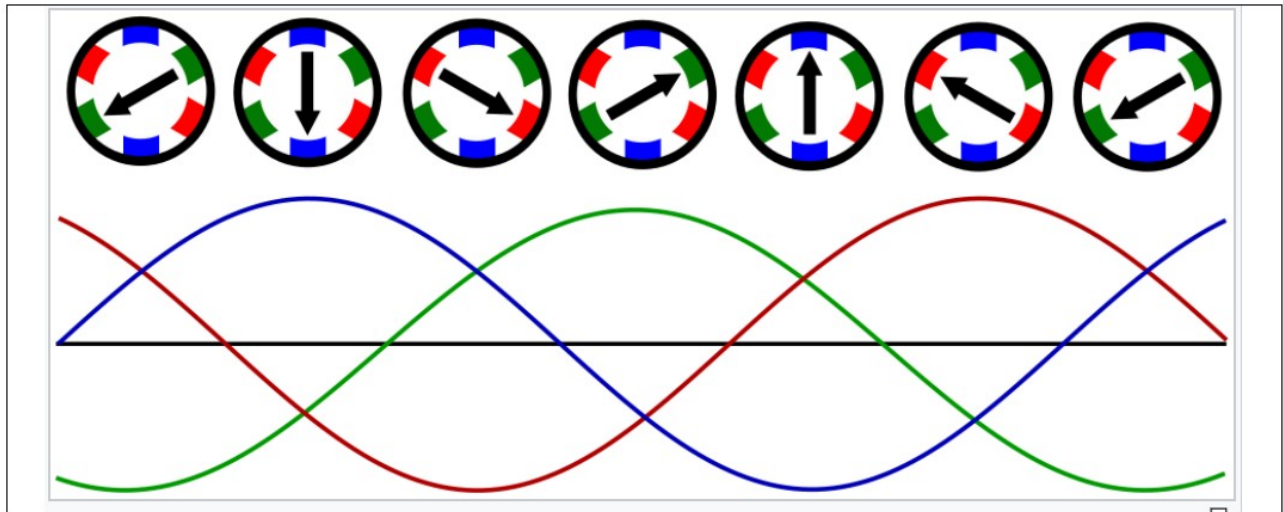
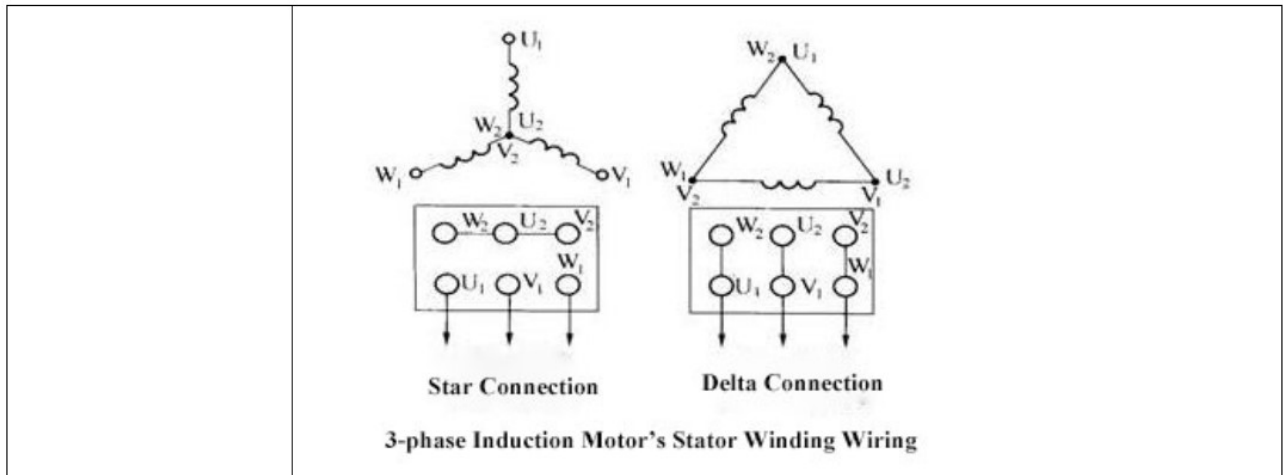

میدان مغناطیسی چرخشی تولید شده توسط سه سیم پیچ استاتور با تغذیه توسط یک سیستم سه فاز

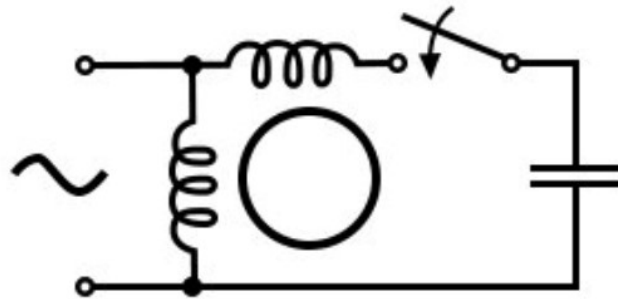

*Capacitor-start induction motor*

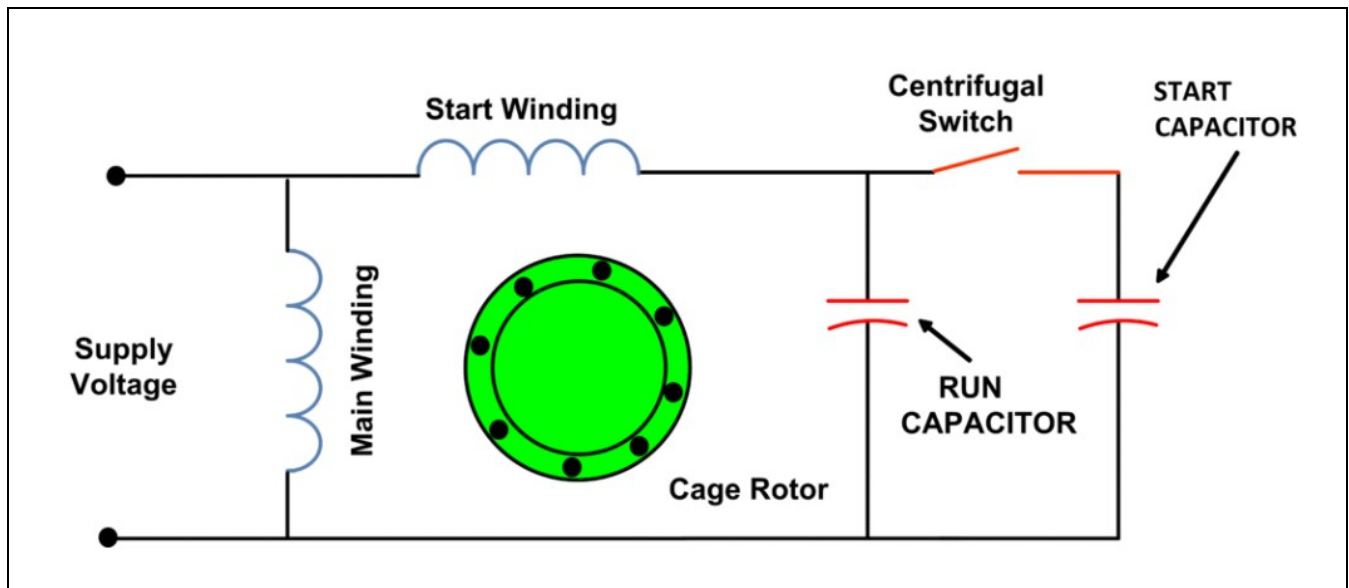



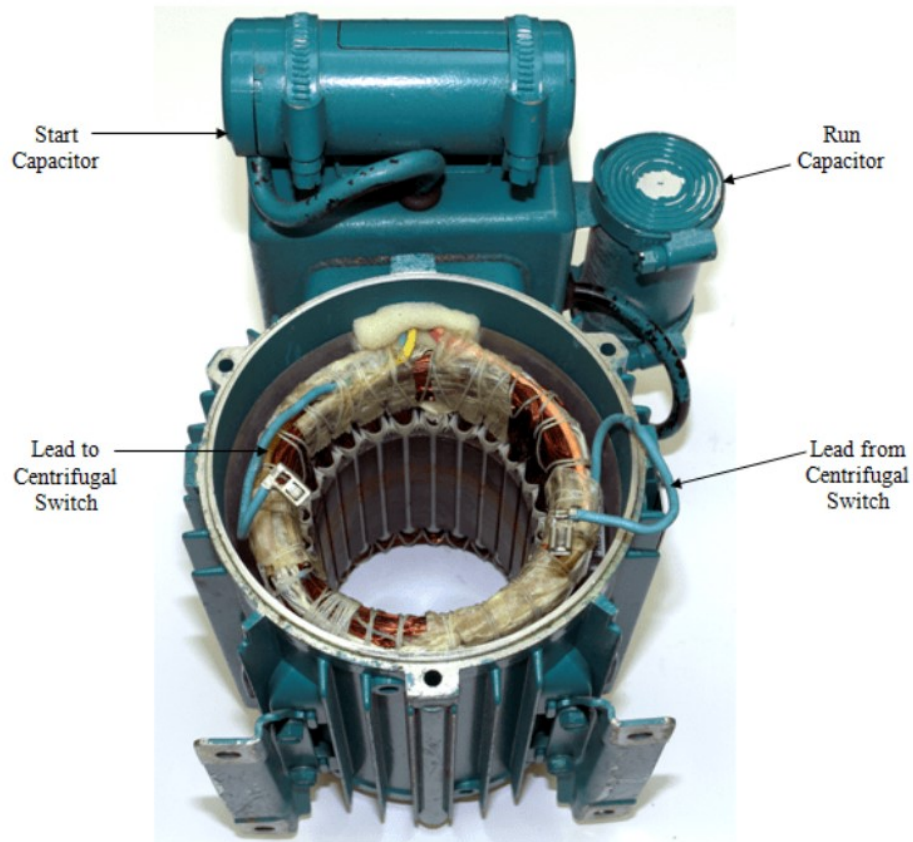

Fig.12: Capacitor Start and Capacitor Run Motor

